

TOKISTAR Micro Display Barlight



The Most Discreet Form of Linear Showcase Lighting



Slim Design Blends into any Setting.

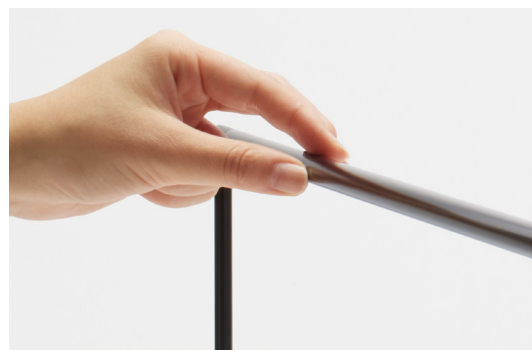

Beam Direction is Easily Adjusted



TOKISTAR® LIGHTING INC.



Micro Display Barlight

With a 12.2 mm diameter, this is the most discreet form of linear showcase lighting. A refined look and 95 CRI rating makes it ideal for illuminating fine jewelry and artifacts in casework and museums. Fixtures have 120° optics and rotate up to 180° on mounting posts. They consume 20 watts per meter and operate at 24VDC.



Specify By Catalog Numbers

MDB - 3000K - L1200 - BK

LED Color		Fixture Length		Finish	
Code	Color	Code	Length	Code	Color
3000	3000K	L600	600 mm	BK	Black
3500	3500K	L1200	1200 mm	CP	Chrome
4000	4000K	Standard Lengths are 600 and 1200 mm. Custom Lengths are available upon request.			
5000	5000K				

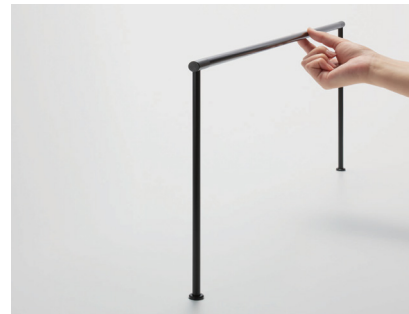

Test Criteria:

Fixture Length: 1200 mm
Fixture Height: 500 mm
Light Source: 3000K LEDs
Lumens: 1625 per Meter
Values: Lux

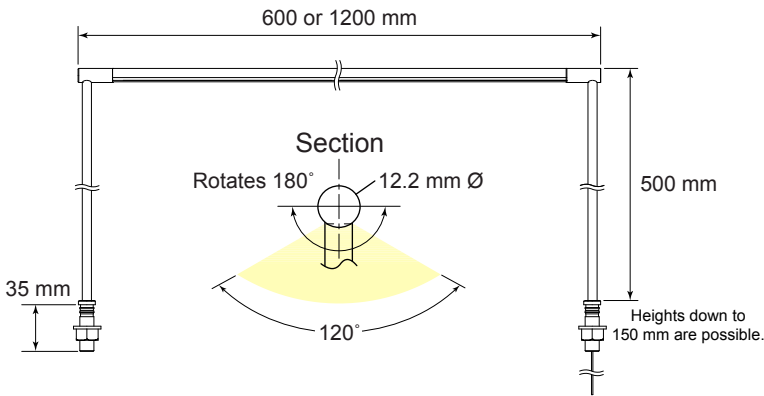
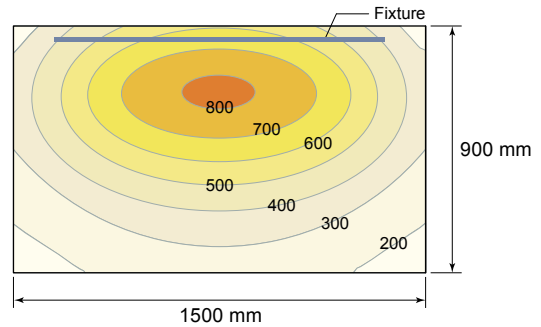

Specifications

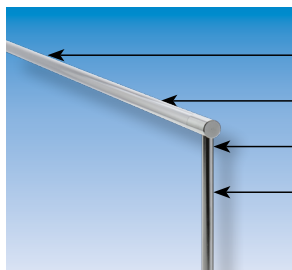

- Light Sources** are LEDs operating at 24VDC
- Fixture** is Aluminum with Polycarbonate Lens
- Mounting Post** is Iron/Plated Chrome or Painted Black
- Conductors** are PVC Insulation with Plated #22AWG x 2

Fixtures are hot to the touch and should not be installed where they come in direct contact with the public.



ETL Listed and Marked in Accordance with CE Standards.



Power Supply

Micro Display Barlight operates from our 24VDC AC Adaptor. This Class 2 power supply has a single output limited to 60 watts/2.5 Amps. Input is 100~240VAC 50/60 Hz.

Part#: LDR24-60

Specifications

Input: 100~240VAC 50/60 Hz
 Output: 24VDC
 Max. Output Current: 2.5A
 Max. Output Power: 60W
 Dims: W 53 x L 120 x H 34 mm
 Compliance: UL Listed Class 2



Non-Dimming Diagram

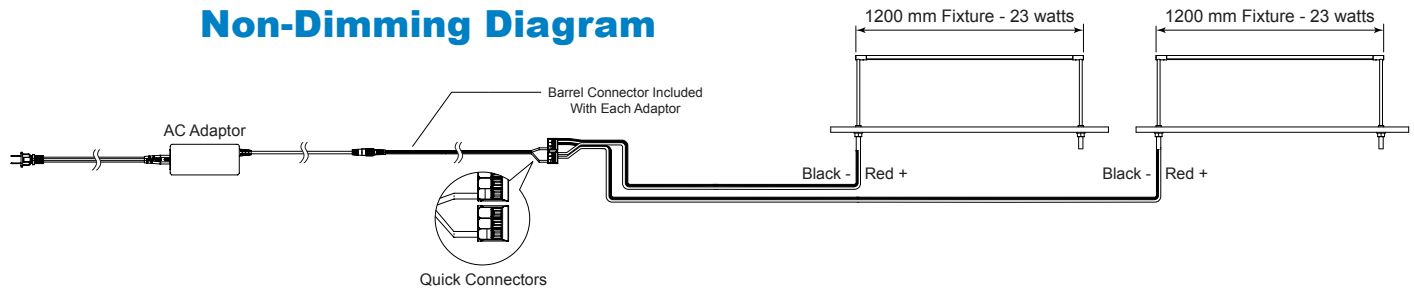

Dimming

Tokistar's EZ-DMR provides finger tip control. An easy dim knob available in Black or Silver allows you to precisely set light levels.

Part#: EZ-DMR-(BK,SV)

Specifications

Input: 24VDC
 Output: PWM
 Max. Output Current: 4A
 Max. Output Power: 60W
 Dims: W 30 x L 78 x H 27 mm

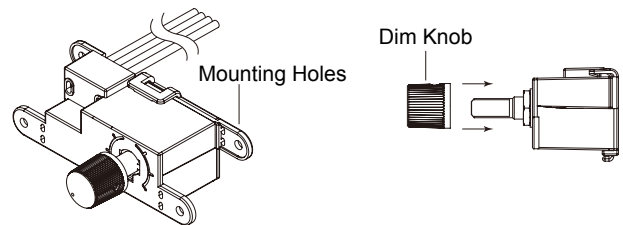

Dimming Diagram

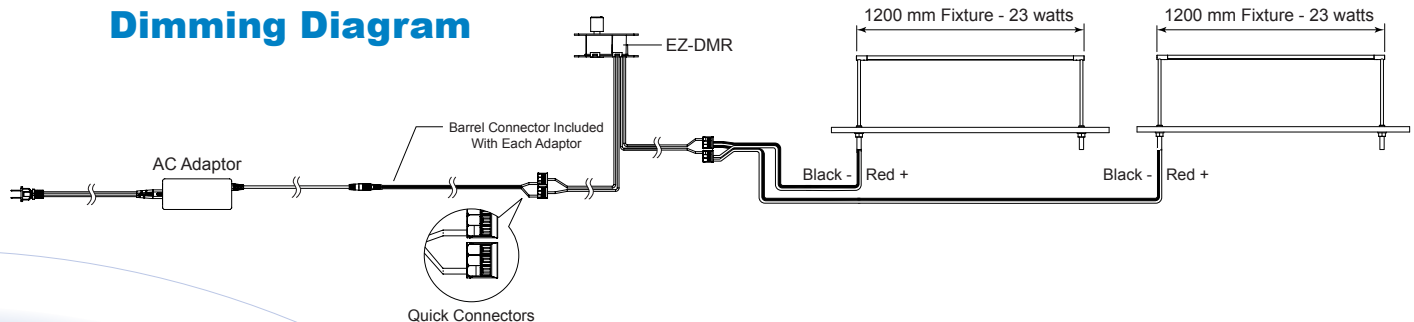

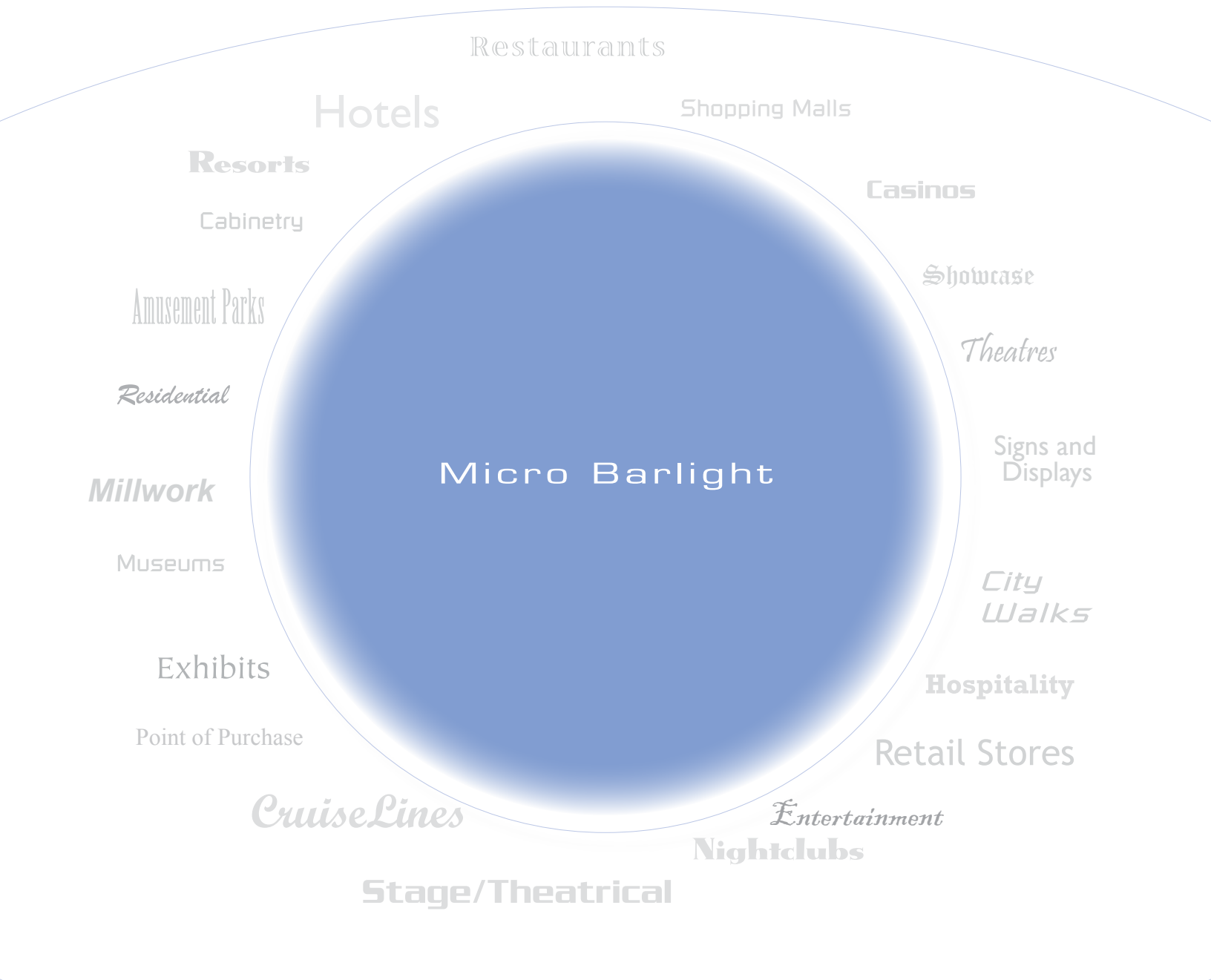

Micro Barlight



TOKISTAR® LIGHTING INC.

1015 E. Discovery Lane • Anaheim, CA 92801

Tel: 714.772.7005 • Fax: 714.772.7014 • Toll free in USA: 877.340.7633

Email: info@tokistar.com • Website: www.tokistar.com